

全新二代防水卷布灯

PATENT PRODUCT! 防水等级:
专利产品! **IPX8** 3米潜水(主灯)

*详情参数资料请参考一代参数

ROLL-FLEX V2.0 SERIES

RX-12TDX(II) RX-18TDX(II) RX-24TDX(II) RX-36TDX(II) RX-48TDX(II)

9种特效: 闪电1、闪电2、电视、烛光、狗仔队、频闪、远近灯光、双闪、呼吸灯



RX-18TDX(II) (100W)

Lux/照度	0.5m	1m	2m
	9920	3660	933



RX-24TDX(II) (150W)

Lux/照度	0.5m	1m	2m
	11600	3790	1060



RX-36TDX(II) (250W)

Lux/照度	0.5m	1m	2m
	15800	6040	1910



RX-48TDX(II) (300W)

Lux/照度	0.5m	1m	2m
	19200	7540	2460

锐鹰影视器材



2020

锐鹰新品
NEW PRODUCT



锐鹰天猫官方旗舰店



京东锐鹰摄影摄像专营店



锐鹰官方微信公众号

锐鹰有限公司 (FALCON EYES LTD.)

Tel: 852-2363-2825 Email: info@falconeyes.com.hk

Fax: 852-2363-3856 Website: http://www.falconeyes.hk

Address: 香港九龙红磡鹤园街2G号恒丰工业大厦一期11字楼E1室

Unit E1, 11/F, Phase 1, Hang Fung Building, 2G Hok Yuen Street, Hung Hom, Kowloon, Hong Kong

深圳市同步影像器材有限公司

SHENZHEN SYNC IMAGE EQUIPMENT CO., LTD

MB: +86 158 1749 2762

QQ: 2850141648 / 3002473709 / 3002471097

Address: 深圳市龙岗区横岗六约深峰路林展财富大厦319 Room 319, Linzhan Fortune Building, Shenfeng Road, Longgang District, Shenzhen, China

Http://www.falconeyes.com.cn

深圳市元科摄影器材有限公司

SHENZHEN FOTOTECH PHOTOGRAPHIC EQUIPMENT CO., LTD

Tel: +86 755 8250 0451 Fax: +86 755 8288 6977

QQ: 2850141641 / 2850141642

Address: 深圳市福田区福虹路世界贸易广场B座18D Unit D, 18/F, Block B, Fuhong Road, World Trade Plaza, Futian District, Shenzhen, China

Http://www.fototech.com.cn

www.falconeyes.com.cn

鹰科影视器材厂

YINGKE PHOTOGRAPHIC EQUIPMENT FACTORY

广东省东莞市凤岗镇黄洞村东深二路东升工业区3号厂房

3rd Building, Dongsheng Industrial Zone (beside The 2nd Dongsheng Road), Huangdong Village, Fenggang Town, Dongguan City, Guangdong Province, China

We reserve the rights to make any changes due to technical developments. © Copyright ,Falcon Eyes Ltd.

全新8系列

RGB 特效彩灯

PATENT PRODUCT!
专利产品!



- ▶ 8系列卷布灯
- ▶ 蒂莎8系列平板柔光灯
- ▶ DM系列聚光灯



苹果市场搜索“DeSal SIK”



安卓下载请联系客服



DeSal SIK

微信搜“锐鹰影视器材”公众号，回复“蒂莎APP”，即可获得下载链接

全新8系列彩灯套用了照明色彩学规范色彩评价指标的CIE1931xy定量坐标色光输出的演算标准。透过xy色度坐标的定量，可达到白光的黑体色温带光色，以及彩色光的群灯灯色一致性效果。

新的灯光控制系统让你可灵活地控制2800K-10000K色温调整以及GM色调效果调整，RGB三基色调光及HSI（色调，饱和度，亮度）彩色调整功能。

更令人兴奋的是全新8系列彩灯内建了色片模式，配备了著名的LEE及ROSCO等多种常用胶片灯色，只需要选择好色号便可快捷地打出你想创造出的灯色效果。

全新8系列彩灯还配备了21种场景模式，具有预设的灯光效果，如警车灯，烛光等。毋需自行编辑程序已可以立即创造特殊的灯光效果，同时全新彩灯系列支持场景模式自定义设置，支持单灯、群灯控制。

此外，全新8系列彩灯还装设了专业级灯光必备的高解析16Bit PWM转DMX-512讯号输出，以及支援智能手机程式控制系统，这样令全新8系列彩灯的应用富有更多可能性，在弹指之间创造出不同的灯光效果。全新8系列彩灯会在将来不断创新开发更多功能并支援韧体更新。

The new DESAL 8-Series is applied with color rendering index CIE1931xy color space calculation standard. Through the quantification of xy color coordinate, it can light color on White LED's black body temperate, and control the color output in consistency.

The new lighting control system gives you flexibility to control color temperature stepless from 2800K to 10000K, color balance G-M +/- 1.0 tuning, RGB colors adjustment, HSI (Hue, Saturation, Intensity) colors adjustment, etc.

What's more exciting is that the new DESAL 8-Series has a built-in Gel mode, which possessed with a variety of commonly use film colors lights from LEE and ROSCO filters. You will only need to select the filter code to quickly generate the light color effect that you want to create.

DESAL 8-Series also equipped with a Theme mode that has preset lighting effects like police car light, candle light, etc. The program-free effects can instantly create special light effect and studio environment.

In addition, DESAL 8-Series is equipped with high-resolution 16Bit PWM to DMX-512 signal output as professional-grade lighting, and it supports DMX control system and also smart phone application to allow even more possibilities on control experience.

With the DESAL 8-Series, there are more possible for a great studio setup that is able to project different light effect in a snap of fingers. The DESAL 8-series will also have continuous firmware upgrade which enable more functions in the future.

适用产品 / Applicable product:

▶ 8系列卷布灯 ROLL-FLEX 8 SERIES



RX-818 RX-824 RX-836 RX-848

▶ 蒂莎8系列平板柔光灯 DESAL 8-SERIES



D-S811 D-S812 D-S814 D-S822

▶ DM系列聚光灯 DM SERIES LED FRESNEL



DM2 DM4

ROLL-FLEX 8 SERIES

RX-818 100W RX-824 150W RX-836 200W RX-848 300W

8系列卷布灯

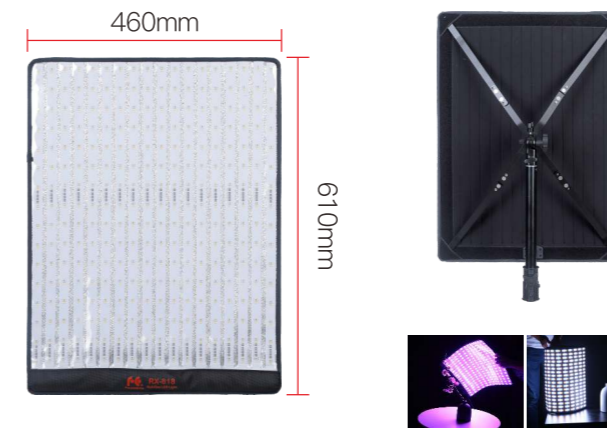

RX-818 (100W)

Lux/照度	0.5m	1m	2m
	6281	2499	660.5

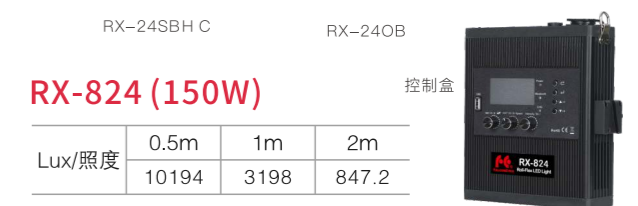

RX-824 (150W)

Lux/照度	0.5m	1m	2m
	10194	3198	847.2

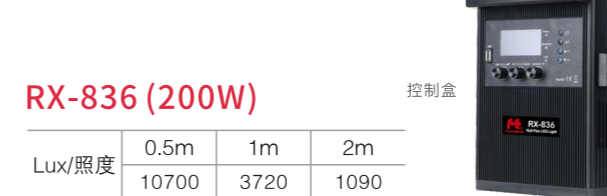

RX-836 (200W)

Lux/照度	0.5m	1m	2m
	10700	3720	1090



RX-848 (300W)

Lux/照度	0.5m	1m	2m
	15600	6020	1790



Model No. 型号	RX-818	RX-824	RX-836	RX-848
LEDs & Power LED 灯泡数及功率	288pcs x 0.5W<暖白> 288pcs x 1.5W<RGB 彩色>	384pcs x 0.5W<暖白> 384pcs x 1.5W<RGB 彩色>	576pcs x 0.5W<暖白> 576pcs x 1.5W<RGB 彩色>	768pcs x 0.5W<暖白> 768pcs x 1.5W<RGB 彩色>
Out put Wattage 输出功率	100W	150W	200W	300W
Color Temperature 色温	2800K - 10000K RGB 彩色			
Operating Voltage 工作电压	AC 110-240V 60 HZ/50HZ			
Dimming 调光	0-100% 无极调光 0-255 饱和度调光			
Compatibility 兼容性	交流电 V卡口电池座			
Control Function 调控方式	开关 / OL液晶屏 / 蓝牙 / 按键 / DMX-512 / 旋钮 / 手机APP			
CRI 显色度	CRI: 96 / TLCI: 95			
Lux 照度	2800K+RGB+W / 0.5M 6280 / 1M 2499 / 2M 660.5 5600K+RGB+W / 0.5M 6180 / 1M 2466 / 2M 656.7	2800K+RGB+W / 0.5M 10194 / 1M 3198 / 2M 847.2 5600K+RGB+W / 0.5M 9880 / 1M 3128 / 2M 835.4	2800K+RGB+W / 0.5M 10400 / 1M 3650 / 2M 1080 5600K+RGB+W / 0.5M 10700 / 1M 3720 / 2M 1090	2800K+RGB+W / 0.5M 15200 / 1M 5880 / 2M 1750 5600K+RGB+W / 0.5M 15600 / 1M 6020 / 2M 1790
Beam Angle 照射角度	0°-360°			
Footcandles 英尺烛光	2800K+RGB+W / 0.5M 584 / 1M 232 / 2M 61 5600K+RGB+W / 0.5M 574 / 1M 229 / 2M 61	2800K+RGB+W / 0.5M 947 / 1M 297 / 2M 79 5600K+RGB+W / 0.5M 918 / 1M 291 / 2M 78	2800K+RGB+W / 0.5M 967 / 1M 339 / 2M 100 5600K+RGB+W / 0.5M 994 / 1M 346 / 2M 101	2800K+RGB+W / 0.5M 1412 / 1M 546 / 2M 163 5600K+RGB+W / 0.5M 1450 / 1M 559 / 2M 166
Dimensions 机身尺寸	布灯: 610×460mm 电源: 285×150×110mm	布灯: 610×610mm 电源: 285×165×110mm	布灯: 1225×465mm 电源: 285×175×110mm	布灯: 1215×610mm 电源: 245×172×105mm
Weight 重量	电源: 2.4KG 布灯: 0.8KG 布罩: 0.6KG X架: 0.25KG	电源: 2.75KG 布灯: 0.97KG 柔光箱: 0.64KG 白布: 0.035KG	电源: 2.85KG 布灯: 1.45KG 柔光箱: 0.86KG 白布: 0.055KG	电源: 2.04KG 布灯: 1.79KG 柔光箱: 1KG 白布: 0.055KG
Temperature 温度	室温: 38°C 产品温度: 58°C			
In the box 配件	X支架+万向接头 控制盒 魔术毛勾贴			
Optional Accessories 选购配件	柔光箱 蜂巢 灯架			

DESAL 8-SERIES

D-S811 200W D-S812 400W D-S814 800W D-S822 800W



D-S811 (200W)

Lux/照度	0.5m	1m	2m
	18600	4645	1201



蒂莎8系列平板柔光灯



D-S812 (400W)

Lux/照度	0.5m	1m	2m
	31786	9380	2385



Model No. 型号	D-S811	D-S812
LEDs & Power LED 灯泡数及功率	280pcs x 1W<暖白> 280pcs x 1.5W<RGB 彩色>	560pcs x 1W<暖白> 560pcs x 1.5W<RGB 彩色>
Out put Wattage 输出功率	200W	400W
Color Temperature 色温	2800K - 10000K RGB 彩色	
Operating Voltage 工作电压	AC 110-240V 60 HZ/50HZ	
Dimming 调光	0-100% 无极调光 0-255 饱和度调光	
Compatibility 兼容性	交流电 V卡口电池座	
Control Function 调控方式	开关 / OL液晶屏 / 蓝牙 / 按键 / DMX-512 / 旋钮 / 手机APP	
CRI 显色度	CRI: 95 / TLCI: 93	
Lux 照度	2800K+RGB+W / 0.5M 23400 / 1M 5610 / 2M 1450 5600K+RGB+W / 0.5M 18800 / 1M 4620 / 2M 1200	2800K+RGB+W / 0.5M 41000 / 1M 10700 / 2M 2810 5600K+RGB+W / 0.5M 34400 / 1M 8890 / 2M 2340
Beam Angle 照射角度	61°	64°
Footcandles 英尺烛光	2800K+RGB+W / 0.5M 2175 / 1M 521 / 2M 135 5600K+RGB+W / 0.5M 1747 / 1M 592 / 2M 112	2800K+RGB+W / 0.5M 3810 / 1M 994 / 2M 261 5600K+RGB+W / 0.5M 3197 / 1M 826 / 2M 217
Dimensions 机身尺寸	493×472×235cm	725×493×235cm
Weight 重量	9.26KG	14.4KG
Noise Level (dB) 噪音分贝强度	温度40°C: 噪音: 20cm:36.5dB 50cm:33.5dB 温度50°C: 噪音: 20cm:43dB 50cm:37.1dB 温度60°C: 噪音: 20cm:44.8dB 50cm:43.1dB	温度40°C: 噪音: 20cm:37.2dB 50cm:34.1dB 温度50°C: 噪音: 20cm:44.1dB 50cm:37.7dB 温度60°C: 噪音: 20cm:51.5dB 50cm:44.5dB
In the box 配件	U架 箱包 (CC-34)	U架 箱包 (CC-35)
Optional Accessories 选购配件	挡光板 柔光箱 蜂巢	

DM系列聚光灯

DM SERIES LED FRESNEL

DM2 200W

DM4 400W

DM2
(200W)



DM4
(400W)



Model No. 型号	DM2	DM4	
LEDs & Power LED 灯泡数及功率	1PCS×200W	1PCS×400W	
Out put Wattage 输出功率	200W	400W	
Color Temperature 色温	2800K - 10000K RGB 彩色		
Operating Voltage 工作电压	AC 110-240V 60 HZ/50HZ		
Dimming 调光	0-100% Stepless Dimming 0-100%无极调光 0-255 Saturation dimming 0-255饱和度调光		
Compatibility 兼容性	AC POWER 交流电		
Control Function 调控方式	开关 / OL液晶屏 / 蓝牙 / 遥控 / 按键 / DMX-512 / 旋钮 / 手机APP		
CRI 显色度	95		
Lux 照度	5600K聚光	0.5M: 64200 1M:16200 3M:1800 5M:709 7M:401 9M:217	0.5M: 123000 1M:31800 3M:3540 5M:1330 7M:710 9M:445
	2800K聚光	0.5M: 54000 1M:13400 3M:2974 5M:618 7M:350 9M:189	0.5M: 102000 1M:26800 3M:2990 5M:1120 7M:601 9M:376
	5600K散光	0.5M: 32400 1M:8040 3M:953 5M:397 7M:227 9M:132	0.5M: 63000 1M:15500 3M:1750 5M:688 7M:379 9M:231
	2800K散光	0.5M: 27600 1M:6960 3M:833 5M:344 7M:196 9M:114	0.5M: 52800 1M:13100 3M:1480 5M:579 7M:321 9M:195
Beam Angle 照射角度	28°-53°		
Footcandles 英尺烛光	5600K聚光	0.5M: 5966 1M:1506 3M:167 5M:66 7M:37 9M:20	0.5M: 11431 1M:2955 3M:329 5M:124 7M:66 9M:41
	2800K聚光	0.5M: 5018 1M:1245 3M:276 5M:57 7M:32 9M:18	0.5M: 9480 1M:2490 3M:278 5M:104 7M:55 9M:35
	5600K散光	0.5M: 3011 1M:747 3M:89 5M:37 7M:21 9M:12	0.5M: 5855 1M:1441 3M:163 5M:64 7M:35 9M:25
	2800K散光	0.5M: 2565 1M:647 3M:77 5M:32 7M:18 9M:11	0.5M: 4907 1M:1217 3M:138 5M:54 7M:30 9M:18
Dimensions 机身尺寸	560×260×250mm		
Weight 重量	7.6KG		
Noise Level (dB) 噪音分贝强度	温度40°C: 噪音:20CM:40.1dB 50CM:36.7dB	温度40°C: 噪音:20CM:40.2dB 50CM:38.4dB	
	温度50°C: 噪音:20CM:42.3dB 50CM:37.5dB	温度50°C: 噪音:20CM:43.1dB 50CM:39.5dB	
	温度60°C: 噪音:20CM:45.8dB 50CM:39.8dB	温度60°C: 噪音:20CM:46.2dB 50CM:41.6dB	

Desal lite

重塑影像控光新体验

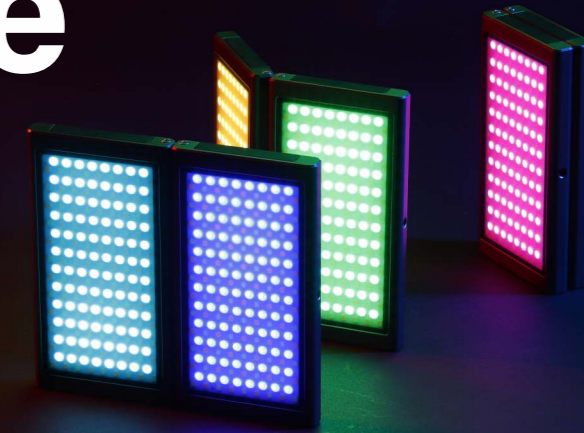

IOS :
搜索“DESAL Lite”下载安装
IOS user search “DESAL Lite”



Android :
手机浏览器扫描二维码下载安装
Use your scan tool scan the QC code to download

灯光无线控制app

通过APP, 可以轻松实现灯光设备调控, 包括色彩调节、色温调节、场景调节、魔法吸色、群组调节等功能。
Adjust lighting equipment on color temperature, RGB, HSI, special effects, color capture, group control, etc.

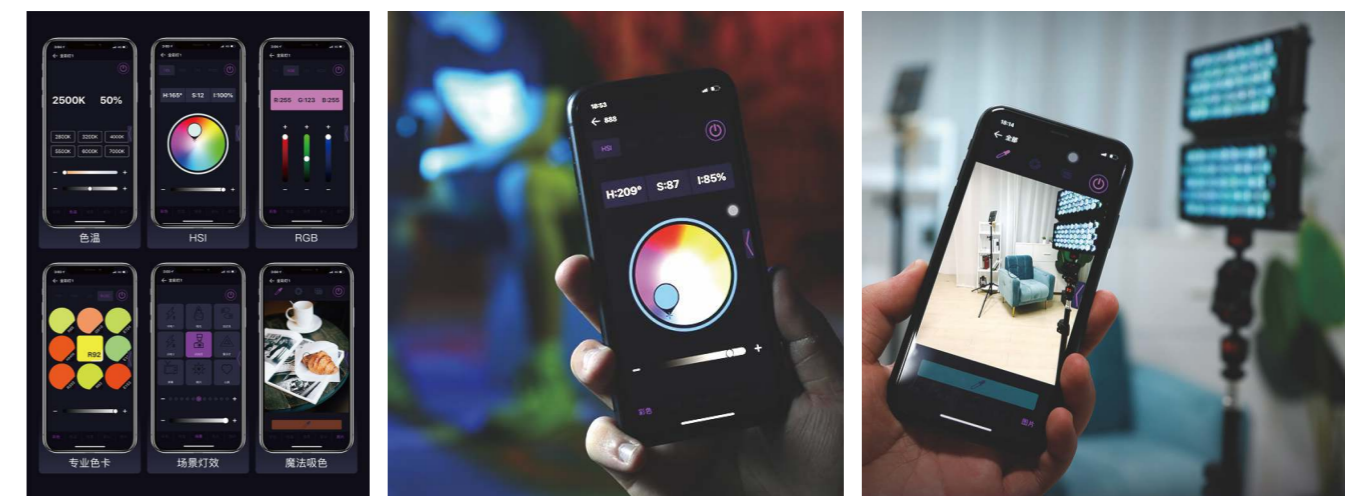

适用产品 / Applicable product:



F7 Fold



DS-711(II)



DS-712(II)



DS-MINI

F7 Fold折叠型RGB补光灯



F7-FOLD RGB Pocket light

2700K-9000K

手机APP调控

PATENT PRODUCT!
专利产品!

The new F7-FOLD RGB Pocket light is designed to be foldable for better storage and lighting angle. The function for F7-FOLD is much more than F7 with the support of smart phone application DeSal Lite which operated by Bluetooth 5.0. With the support of APP user can unlock more functions like Rosco & LEE filters, Color capture, RGB control and programming. The battery life of F7-FOLD can live up to 150 hours under 100% output which is more than most Pocket RGB LED on the market.

F7-FOLD is coming with full accessories like diffuser, 2 honeycomb grids, charging cable and mounting system which you can apply to your work hustle free.



pockelite全新推出F7 fold折叠型RGB补光灯, 9寸光照面积使它打开时像一个ipad mini大小, 180度折叠后秒变6寸可以塞进口袋中, 可通过Desal Lite手机App多灯群组控制, 可折叠的灯光设计让补光使用极具多样性, 包含CCT模式(2500-9000K恒定输出)+无极调光、HSI模式和RGB模式轻松调节36000种色彩、内置LEE和ROSCO色纸让您的布光变得更加简单、20种场景特效可调节速度和亮度增强了实用和可操作性、图片取色功能让它变得更好玩。做为一款拥有58Wh内置电池的补光灯, 最亮模式长达150分钟的续航几乎可以秒杀一众口袋灯, 而24W的超大功率, 在能塞进口袋的补光灯中更是堪称没有对手。一款好用的补光灯更离不开丰富的配件-异形柔光罩改变传统柔光罩的玩法、硅胶蜂巢还是那么酷、超大蛋格Honeycomb 9"让你的创作变得更有灵感。

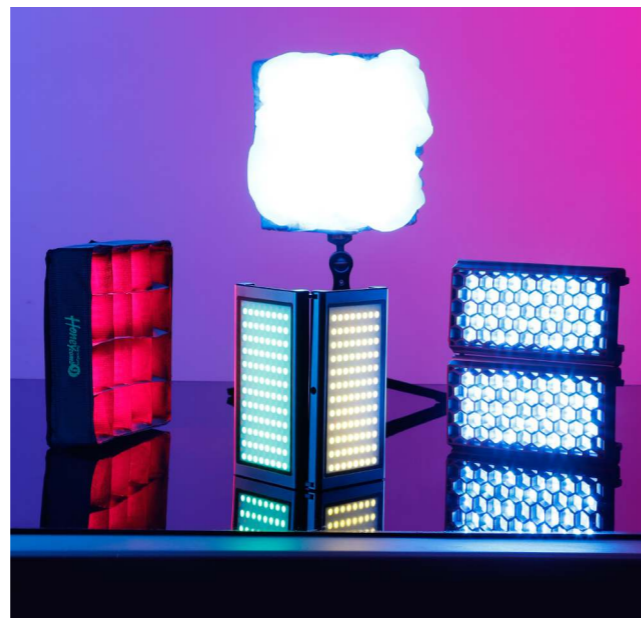

Model No. 型号	F7 Fold
LEDs & Power LED 灯泡数及功率	108pcs x 0.5W<白White> 108pcs x 0.5W<黄Yellow> 192pcs x 0.5W<彩色RGB>
Out put Wattage 输出功率	24W
Color Temperature 色温	2500K-9000K
Operating Voltage 工作电压	5-15V 2A
Dimming 调光	0-100%
Compatibility 兼容性	type-C充电口 输入电压:5-15V 2A 支持QC3.0快充协议
Control Function 调控方式	旋钮 / APP
CRI 显色度	CRI 96

Lux 照度	2500K: 0.3M: 10700 0.5M: 3990 / 1M: 965 5600K: 0.3M: 11200 0.5M: 4010 / 1M: 972
Beam Angle 照射角度	110°
Footcandles 英尺烛光	2500K: 0.3M: 994 0.5M: 371 / 1M: 89 5600K: 0.3M: 1040 0.5M: 373 / 1M: 90
Dimensions 机身尺寸	173 x 160 x 15mm
Weight 重量	685g
Temperature 温度	亮灯状态Lighting - 8°c - 38°c 充电状态Charging 0°c - 35°c 储存环境Storage - 8°c - 65°c
Battery Capacity 电池容量	7.6V 7600m Ah (3800mAh x2) 57.6Wh (28.8Wh x2)

PATENT PRODUCT!
专利产品!

DESAL 7 V2.0 SERIES

DS-711(II) 150W

DS-712(II) 200W

蒂莎7系列(II代)

锐鹰公司的蒂莎7系列全彩灯现推出第二代加强版, 可以利用RGB灯创造出各式各样的灯光效果, 并附有20种预设场景模式。

蒂莎系列的亮点在于可以同时利用黄色及白色LED, 而且色温范围广, 可由3000K-5600K。RGB LED现已升级为HSI控制, 调色更容易更细致。

蒂莎7系列第二代同时亦支援DMX控制系统, 而且可令蒂莎全彩柔光灯的应用富更多可能性。蒂莎全彩柔光灯的20种预设场景模式, 作出不同的动感光效, 如警车灯效果, 或其他任何动态光效。这将会成为在影视及舞台上一个优质解决方案。

蒂莎7系列第二代已经有一系列不同形态的产品如平板灯及布灯。令使用色彩布光能有更多便利及可塑性。

The new 2.0 version from DESAL 7 is now available with up to 20 different preset special effects and with full HSI control which user can have more detail setting on colors and effects. Despite of DMX control, the new 2.0 version is also supporting the new DeSal Lite APP via Bluetooth 5.0. With the support of APP user can unlock more functions like Rosco & LEE filters, Color capture, RGB control and programming.



DS-711(II)



DS-712(II)

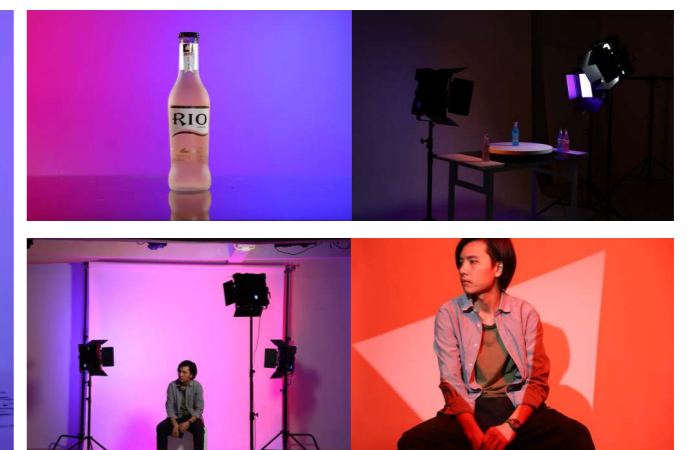

DS-MINI (40W)

PATENT PRODUCT!
专利产品!

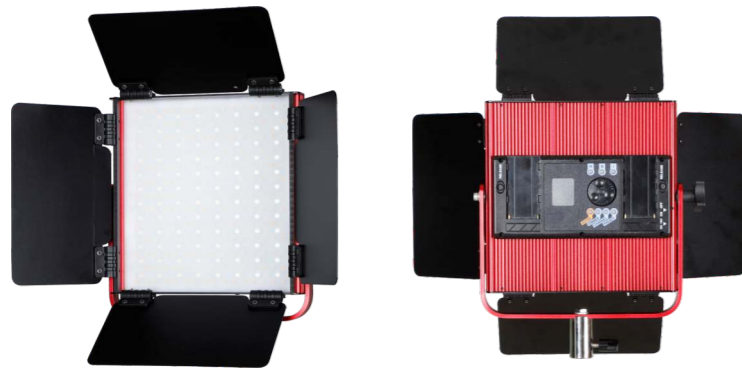

DS-MINI (40W) 20种特效

Lux/照度	0.5m	1m	2m
	5680	1470	380

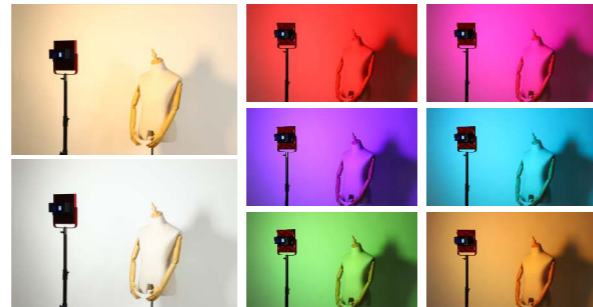

Model No. 型号	D-S711(II)	D-S712(II)	DS-MINI
LEDs & Power LED 灯泡数及功率	216pcs x 0.5W<白>/216pcs x 0.5W<黄> 204pcs x 0.3W<彩色>	420pcs x 0.5W<白>/420pcs x 0.5W<黄> 406pcs x 0.3W<彩色>	104pcs x 0.5W<白>/104pcs x 0.5W<黄> 96pcs x 1.5W<彩色>
Out put Wattage 输出功率	100W	200W	40W
Color Temperature 色温	3000K-5600K	3000K-5600K	3000K-5600K
Operating Voltage 工作电压	DC-16.8V/8A	AC 110-240V 60 HZ/50HZ	DC-15V 5A
Dimming 调光	0-100% Step-less dimming 蓝牙/按键	0-100% Step-less dimming 蓝牙/按键	0-100% Step-less dimming Turning Knob 旋钮
Compatibility 兼容性	AC Adaptor 适配器 Sony V Mount Battery (DC) V卡口电池座	AC POWER 交流电 Sony V Mount Battery (DC) V卡口电池座	AC Adaptor 适配器 Sony F Mount Battery 锂电池
Control Function 调控方式	DMX-512/Turning Knob 旋钮/ 遥控/APP	DMX-512/Turning Knob 旋钮/ 遥控/APP	ON/OFF 开关 点阵液晶屏 遥控RC-5/APP
CRI 显色度	96	97	96
Lux 照度	5600K / 0.5M 10700 / 1M 2690 / 2M 689 3000K / 0.5M 9580 / 1M 2390 / 2M 618	5600K / 0.5M 17700 / 1M 4940 / 2M 1330 3000K / 0.5M 16000 / 1M 4430 / 2M 1190	5600K / 0.5M 5680 / 1M 1470 / 2M 380 3000K / 0.5M 4990 / 1M 1280 / 2M 335
Beam Angle 照射角度	61°	66°	63°
Footcandles 英尺烛光	5600K / 0.5M 994 / 1M 250 / 2M 64 2700K / 0.5M 890 / 1M 222 / 2M 57	5600K / 0.5M 1644 / 1M 459 / 2M 123 2700K / 0.5M 1486 / 1M 411 / 2M 110	5600K / 0.5M 528 / 1M 137 / 2M 35 3000K / 0.5M 464 / 1M 119 / 2M 31
Dimensions 机身尺寸	420×410×130mm	710×450×140mm	300×268×45mm
Weight 重量	3.76KG	7.35KG	1.56 KG
In the box 配件	U-Bracket U架 Carry Bag 布袋	U-Bracket U架 Carry Bag 布袋	U-Bracket U架 挡光板 Carry Bag 布袋
Optional Accessories 选购配件	挡光板 柔光箱 蜂巢 遥控器 RC-5A III	挡光板 柔光箱 蜂巢 遥控器 RC-5A III	遥控器 RC-5A III

PATENT PRODUCT!
专利产品!

NEW PRODUCT

LPL-S1602T/TD 32W LPL-S3602TD 72W

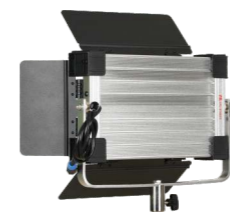

LPL-S1602T/TD 32W

Lux/照度	0.5m	1m	2m
	650	261	181



平板柔光灯-LPL镜系列

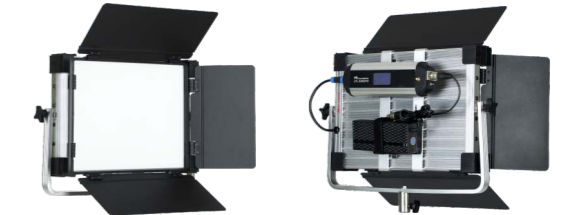

LPL-S3602TD 72W

Lux/照度	0.5m	1m	2m
	8010	2110	576



Model No. 型号	LPL-S1602T/TD	LPL-S3602TD
LEDs & Power LED 灯泡数及功率	160pcs x 0.2W (LPL-S1602T) 160pcs x 0.5W (LPL-S1602TD)	576pcs x 0.5W
Out put Wattage 输出功率	32W	72W
Color Temperature 色温	3000K/5600K (LPL-S1602T) 3000K-5600K (LPL-S1602TD)	3000K-5600K
Operating Voltage 工作电压	DC-16.8V 5A	DC-16.8V 7A
Dimming 调光	0-100% Step-less dimming 0-100% 无极调光	
Compatibility 兼容性	AC Adaptor 适配器 Sony V Mount Battery (DC) V卡口电池座	
Control Function 调控方式	Turning Knob 旋钮	Touch Screen 触屏 Mutual Control 互控
CRI 显色度	95	
Lux 照度	0.5M:650 1M:261 2M:181 (5600k)	0.5M:8010 1M:2110 2M: 576 (5600k)
Beam Angle 照射角度	68°	
Footcandles 英尺烛光	0.5M:60 1M:24 2M: 17 (5600k)	0.5M:744 1M:196 2M: 54 (5600k)
Dimensions 机身尺寸	400×290×40mm	520×390×40mm
Weight 重量	1.89KG	4.3KG
In the box 配件	U-Bracket U架 Carry Bag 布袋 Adaptor DC-16.8V 适配器DC-16.8V Control Box 控制盒 V-Mount battery plate V卡口电池座 Control Box Clip 控制盒夹: CL-25U	
Optional Accessories 选购配件	Light Stand 灯架: I-2001/B Li-ion Battery 锂电池:BP-100L BD挡光板 WPC 3.1 Water Proof Case 抗压防水箱 AD-PS1 SP-XC04(4m) SP-XC06(6m) SP-XC08(8m) SP-XC10(10m)	Light Stand 灯架: I-2601/B BD挡光板 AD-PS1 Li-ion Battery 锂电池: BP-100L 遥控器 RC-6 SP-XC04(4m) SP-XC06(6m) SP-XC08(8m) SP-XC10(10m)

苏菲导光柔光灯

PATENT PRODUCT!
专利产品!

9种特效场景/9 SPECIAL EFFECTS SCENE



SO-48TDX II & SO-68TDX II

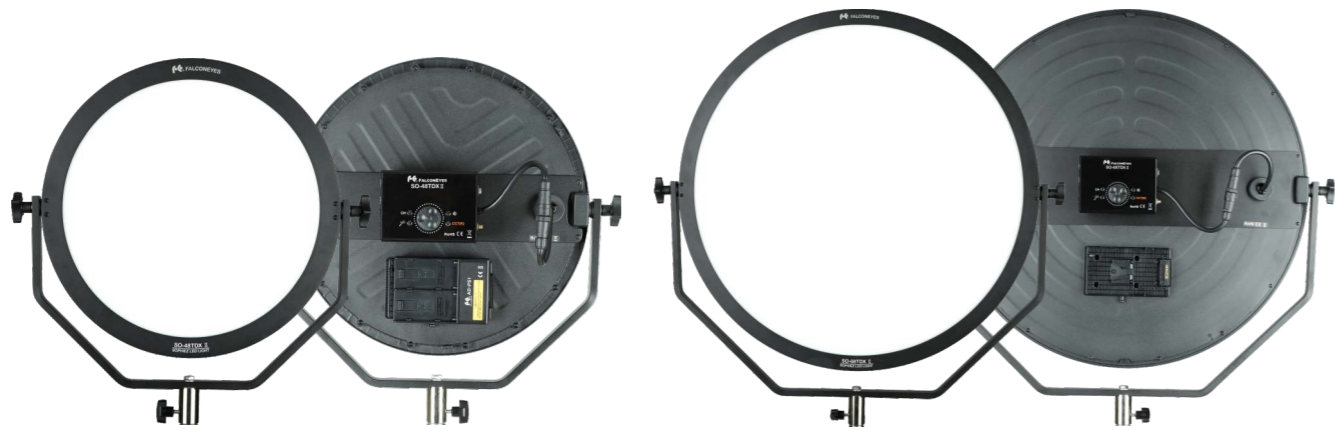

Control Box 控制盒



- BORN IN THIN 超薄机身
- COLORITE 高显色
- REMOTE CONTROL 无线遥控
- DMX-READY DMX操控

SO-48TDX II 功率:48W Dia.400mm

Lux/照度	0.5m	1m	2m
	4700	1260	341



SO-68TDX II 功率:68W Dia.600mm

Lux/照度	0.5m	1m	2m
	5920	1660	467



Model No. 型号	SO-48TDX II	SO-68TDX II
LEDs & Power LED 灯泡数及功率	240pcs x 0.5W	360pcs x 0.5W
Out put Wattage 输出功率	48W	68W
Color Temperature 色温	3000K-5600K	
Operating Voltage 工作电压	DC-15V 5A	DC-15V 7A
Dimming 调光	Color Temperature 3000-5600K / 0-100% Intensity色温 3000-5600K / 0-100% 无极调光	
Compatibility 兼容性	AC Adaptor 适配器 Sony V Mount Battery (DC) V卡口电池座 Sony F Mount Battery 锂电池 (x 2)	
Control Function 调控方式	ON/OFF 开关 Turning Knob 旋钮 Remote Control 无线遥控	
CRI 显色度	95	
Lux 照度	5600K: 0.5M 4700 / 1M 1260 / 2M 341 3000K: 0.5M 3300 / 1M 889 / 2M 269	5600K: 0.5M 5920 / 1M 1660 / 2M 467 3000K: 0.5M 4190 / 1M 1190 / 2M 336
Beam Angle 照射角度	65°	
Footcandles 英尺烛光	5600K: 0.5M 437 / 1M 117 / 2M 32 3000K: 0.5M 307 / 1M /83 /2M 25	5600K: 0.5M 550 / 1M 154 / 2M 43 3000K: 0.5M 389 / 1M 110 / 2M 31
Dimensions 机身尺寸	Φ400mm(Inter dia/发光面) 485×465×65mm	Φ600mm(Inter dia/发光面) 685×670×65mm
Weight 重量	2.33kg	4.1kg
Mounting Method 安装配套	U-BRACKET U架	
In the box 配件	AC Adaptor 适配器 BAG 布袋 AD-PS1 转换器	
Optional Accessories 选购配件	Li-ion Battery 锂电池: BP-100L Battery Charger 充电器:FC-B1 Sony F-mount Li-ion Battery 锂电池: NP-F750F/NP-F960F Battery Charger 充电器:SP-CHG Light Booms横臂灯架:LSB-3 Light Stand 灯架: I-2501 遥控器 RC-5B	Li-ion Battery 锂电池: BP-100L Battery Charger 充电器:FC-B1 Sony F-mount Li-ion Battery 锂电池: NP-F960F Battery Charger 充电器:SP-CHG Light Booms横臂灯架:LSB-4 Light Stand 灯架: I-2601/B 遥控器 RC-5B

9种特效场景/9 SPECIAL EFFECTS SCENE



PATENT PRODUCT!
专利产品!

苏菲直射柔光灯

SO-150TDX & SO-300TDX

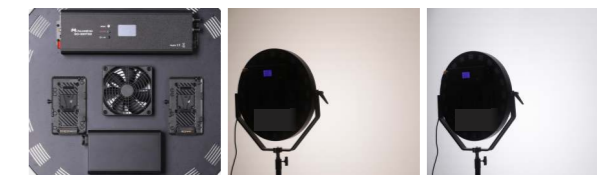

SO-150TDX 功率:150W Dia.450mm

Lux/照度	0.5m	1m	2m
	19100	5000	1320



SO-300TDX 功率:300W Dia.600mm

Lux/照度	0.5m	1m	2m
	25100	7200	1980



Model No. 型号	SO-150TDX	SO-300TDX
LEDs & Power LED 灯泡数及功率	720Pcs×0.5W	1248Pcs×0.5W
Out put Wattage 输出功率	150W	300W
Color Temperature 色温	2800K-6500K	
Operating Voltage 工作电压	AC 100V-240V 50Hz/60Hz	
Dimming 调光	0-100% 无极调光	
Compatibility 兼容性	AC POWER 交流电 Sony V Mount Battery(DC)V卡口电池座	
Control Function 调控方式	触屏 旋钮 DMX 2.4G/DMX-512/Turning Knob 旋钮/遥控	
CRI 显色度	97	
Lux 照度	5600K / 0.5M 19100 / 1M 5000 / 2M 1320 2800K / 0.5M 14600 / 1M 3750 / 2M 992	5600K / 0.5M 25100 / 1M 7200 / 2M 1980 3000K / 0.5M 22500 / 1M 6300 / 2M 1760
Beam Angle 照射角度	62°	66°
Footcandles 英尺烛光	5600K / 0.5M 1775 / 1M 456 / 2M 123 2800K / 0.5M 1357 / 1M 349 / 2M 92	5600K / 0.5M 2333 / 1M 669 / 2M 184 3000K / 0.5M 2091 / 1M 586 / 2M 164
Dimensions 机身尺寸	560×560×105mm	780×700×100mm
Weight 重量	5.33kg	9.3kg
Mounting Method 安装配套	U-Bracket U架	
Noise Level (dB) 噪音分贝强度	0.2M:45.1dB 0.5M:41dB 1M:38dB	0.2M:52.8dB 0.5M:46.6dB 1M:41.2dB
In the box 配件	U-Bracket U架 Carry Bag 布袋	
Optional Accessories 选购配件	遥控器 RC-7	

直播补光灯

LPS-150T / LPS-200TD / BL-30TD II

直播补光、视频拍摄、照片拍摄
CRI ≥96 大功率、高亮度 **PATENT PRODUCT! 专利产品!**



LPS-150T (150W)

Lux/照度	0.5m	1m	2m
	109000	18400	4280



9种特效场景/9 SPECIAL EFFECTS SCENE



LPS-200TD (200W)

Lux/照度	0.5m	1m	2m
	158000	23500	5050



BL-30TD II (300W)

Lux/照度	0.5m	1m	2m
	156000	24400	5480



9种特效场景/9 SPECIAL EFFECTS SCENE



Model No. 型号	LPS-150T	LPS-200TD	BL-30TD II
LEDs & Power LED 灯泡数及功率	1Pcs×150W	1Pcs×200W	1Pcs×300W
Out put Wattage 输出功率	150W	200W	300W
Color Temperature 色温	5600K	3000K-8000K	3000K-8000K
Operating Voltage 工作电压	AC100V-240V	AC100V-240V	AC-110V-240V
Dimming 调光	0-100% Stepless Dimming 0-100% 无极调光	0-100% Stepless Dimming 0-100% 无极调光	0-100% Stepless Dimming 0-100% 无极调光
Compatibility 兼容性	AC POWER 交流电/DC电源	AC POWER 交流电/DC电源	AC POWER 交流电 Sony V Mount Battery (DC) V卡口电池座
Control Function 调控方式	按钮 / DMX-512 / OLED液晶屏	Turning Knob 旋钮 WiFi Application 无线WIFI Touch Screen 轻触屏	Touch Screen Turning knob DMX 2.4G remote / RC-5C 按钮 / 旋钮 DMX 2.4G遥控器 RC-5C
CRI 显色度	96	96	95
Lux 照度	5600K / 0.5M109000 / 1M 18400 / 2M 4280 / 3M 1900	5600K / 0.5M158000 / 1M 23500 / 2M 5050 / 3M 2210	5600K 0.5M:156000 1M:24400 2M:5480 3M:2410 5M:951 3000K 0.5M:70900 1M:11100 2M:2510 3M:1100 5M:434
Beam Angle 照射角度	30°	27°	34°
Footcandles 英尺烛光	5600K / 0.5M 10130/ 1M 1710 / 2M 398 / 3M 177	5600K / 0.5M 14684/ 1M 2184 / 2M 469 / 3M 205	5600K 0.5M:14498 1M:2268 2M:509 3M:224 5M:88 3000K 0.5M:6589 1M:1032 2M:233 3M:102 5M:40
Dimensions 机身尺寸	420x185x140mm	616x220x130mm	490×210×150mm
Weight 重量	2.1Kg	3.6Kg	灯:2.75KG 电源:2.51KG
Noise Level (dB) 噪音分贝强度	0.2M:44.3dB 0.5M:38.3dB	0.2M:49.7dB 0.5M:42.1dB	灯 0.2M:47.1dB 0.5M:40.5dB 电源 0.2M:42dB 0.5M:37.1dB
In the box 配件	标准罩/电源线	标准罩/色罩/电源线	标准罩/控制盒/电源线/U架
Optional Accessories 选购配件	/	/	遥控器 RC-5C

保荣卡口 抛物线蜂巢柔光箱 Parabolic Foldable Honeycomb Softbox



快拆快装卡盘

SPB90+HC

SPB70+HC

锐鹰深口抛物线蜂巢柔光箱采用新一代快装快拆卡盘以及16根钢制伞骨，一拉一按，即可轻松完成安装和拆卸，解决了柔光箱拆装困难的问题。



LPS-200TD

LPS-200TD+灯箱

LPS-200TD+灯箱+柔光布

LPS-200TD+灯箱+蜂巢栅格