

Instruction Manual

For DESAL-8 series

RGB LIGHTING 2.0



Desa



Falcon Eyes Limited 銳鷹有限公司
香港九龍紅磡鶴園街2G號恆豐大廈1期11樓E1室
Unit E1, 11F, Phase 1, Hang Fung Building, 2G Hok Yuen Street, Hung Hom, Kowloon, Hong Kong.

Phone: +852-2365 2915
E-mail: sales@falconeyes.hk / info@falconeyes.com.hk
www.falconeyes.hk
www.facebook.com/falconeyeshk
www.instagram.com/falconeyeshk/

Falcon Eyes Retail Shop 銳鷹零售店
香港九龍紅磡馬頭圍道39號紅磡廣場一樓25舖
Unit 25, 1/F, Hung Hom Square, 39 Ma Tau Wai Road,
Hung Hom, Kowloon, Hong Kong
Phone: +852 2363 3620

Yingke Photographic Equipment Factory (Falcon Eyes)
鷹科攝影器材廠 (銳鷹)

廣東省東莞市鳳崗鎮黃洞村東深二路邊東昇工業區3號廠房
3rd Building, Dongsheng Industrial Zone (beside the 2nd dongsheng road),
Huangdong Village, Fenggang Town, Dongguan City, Guangdong Province. China

(0769) 8729 8687

Precautions 注意时项

- ▶ Please read this manual before using the light and follow the instructions.
使用前请先仔细阅读此说明书。
- ▶ Make sure that the product is intact and that there are no missing parts.
请检查产品是否完整及无任何配件遗漏。
- ▶ Keep the environment dry and ventilated when using the product.
请在通风及干爽的环境使用本产品。
- ▶ Do not leave or use the light in humid or dusty environment.
请避免在潮湿及尘土飞扬的环境下使用本产品。
- ▶ Clean this product with only a soft and dry cloth.
请使用柔软及干的布料来清洁产品。
- ▶ Do not plug/unplug when the power is still connected.
在插入/拔除电源前请先确认电源按钮已关闭。
- ▶ Keep this light away from children.
请存放此灯在儿童接触不到的地方。
- ▶ Do not open or repair the unit yourself. If there is any defect, please contact an experienced technician.
切勿尝试自行拆开产品进行维修, 如需维修请联络专业电工/供应商。
- ▶ Do not apply pressure to the product.
请勿施加重力在产品上。
- ▶ Do not exceed the maximum load capacity.
切勿以过高电源使用产品。

感谢您选购锐鹰公司的产品!

如欲了解更多相关产品的信息, 请联系您当地的经销商或访问我们的网页。使用产品之前, 请先仔细阅读说明书。

Thank you for purchasing FalconEyes' products.

For further details of our related products, please contact your local distributor or visit our webpage at www.falconeyes.com.cn, Thank you.

Please read this manual carefully before using this product.

CONTENTS

1、Product Introduction	14
2、Product Outlook	16
3、Function Introduction	20
4、DMX-512 Setting	22
5、Application Settings	23
6、Mobile version update	24
7、Accessories Introduction	24

1/Product Introduction

The new DESAL 8-Series is applied with color rendering index CIE1931xy color space calculation standard. Through the quantification of X color coordinate, it can light color on White LED's black body temperature, and control the color output in consistency.

The new lighting control system gives you flexibility to control color temperature steps from 2800K to 10000K, color balance G-M +/- 1.0 tuning, RGB colors adjustment, HSI (Hue, Saturation, Intensity) colors adjustment, etc.

What's more exciting is that the new DESAL 8-Series has a built-in Gel mode, which possessed with a variety of commonly use film colors lights from LEE and ROSCO filters. You will only need to select the filter code to quickly generate the light color effect that you want to create.

DESAL 8-Series also equipped with a Theme mode that has preset lighting effects like police car light, candle light, etc. The program-free effects can instantly create special light effect and studio environment.

In addition, DESAL 8-Series is equipped with high-resolution 16Bit PWM to DMX-512 signal output as professional-grade lighting, and it supports DMX control system and also smart phone application to allow even more possibilities on control experience.

With the DESAL 8-Series, there are more possible for a great studio setup that is able to project different light effect in a snap of fingers. The DESAL 8-series will also have continuous firmware upgrade which enable more functions in the future.

DESAL 8-SERIES

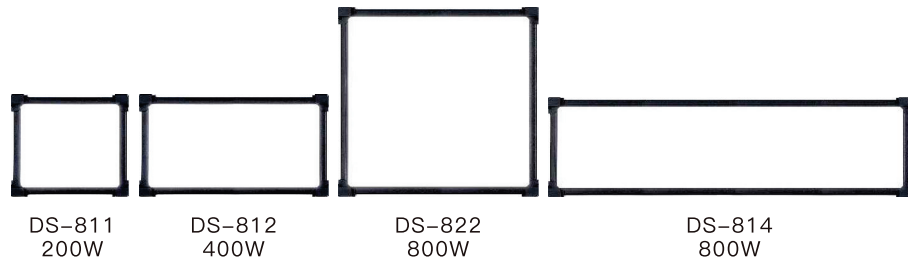

ROLL-FLEX RGB SERIES

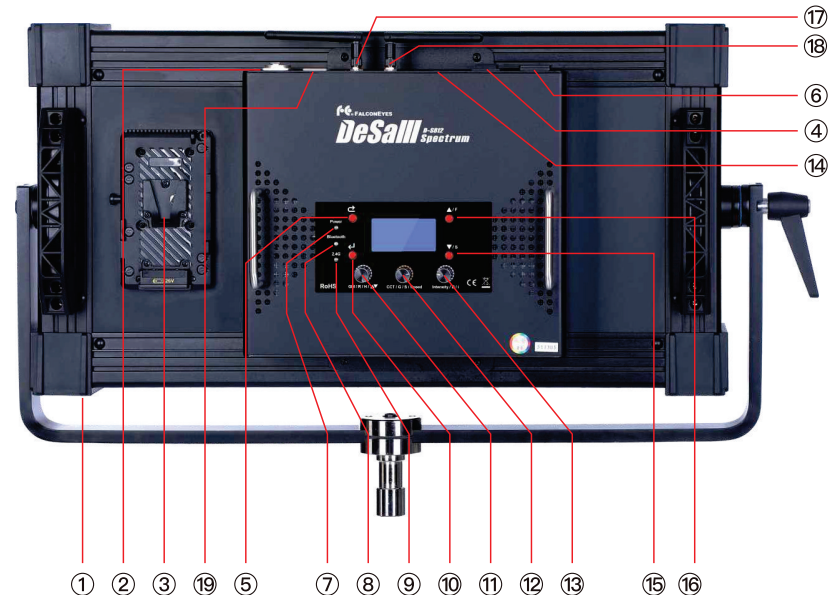
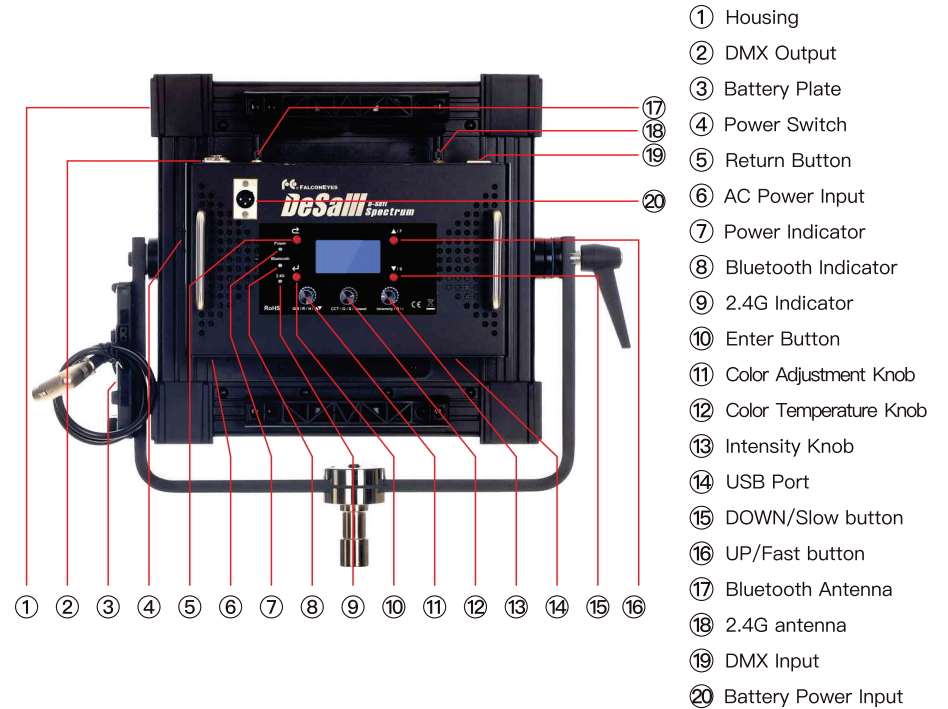
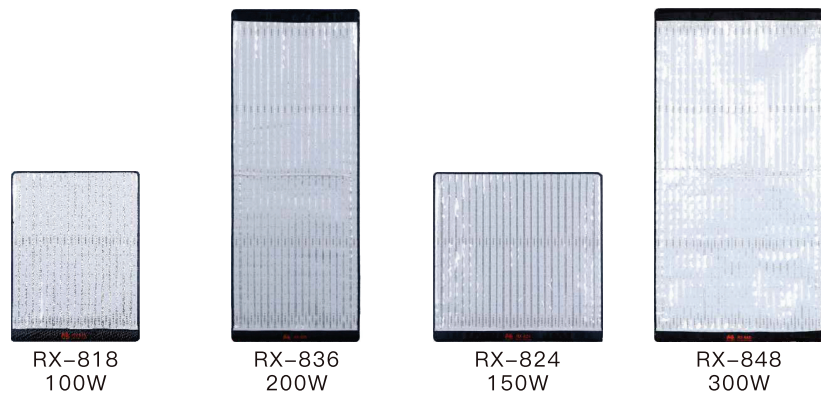

2/Product Outlook

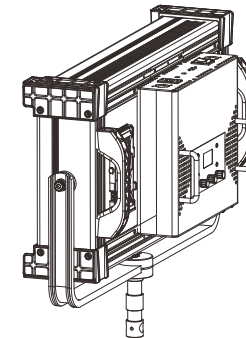
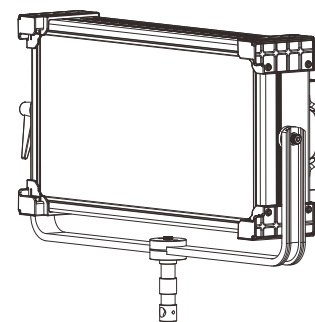
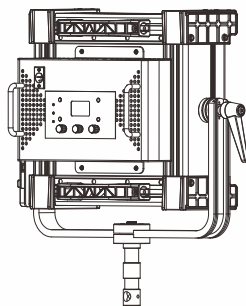
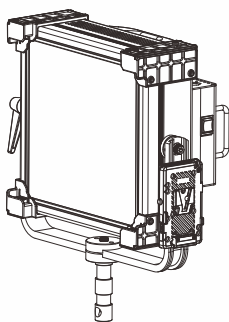
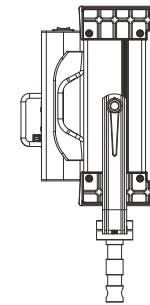
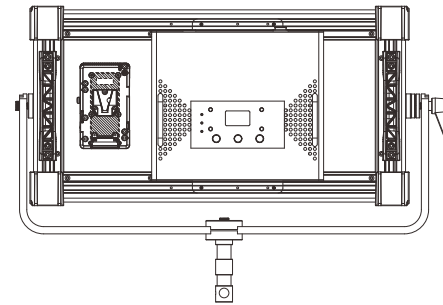
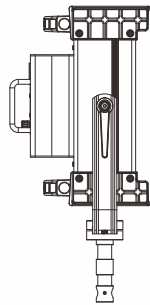
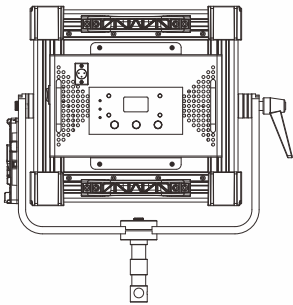
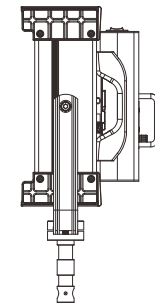
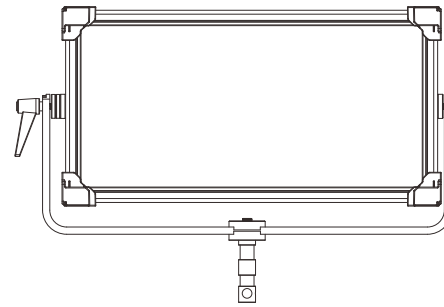
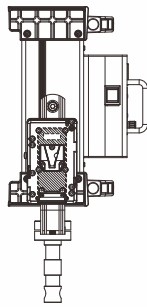
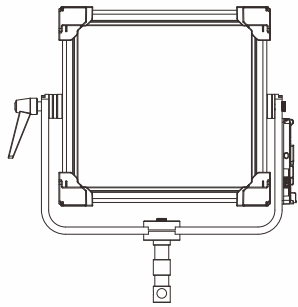

DS-811

495x470x235mm N.W.: 9.26KG

DS-812

735x492x236mm N.W.: 14.4KG



RX-818

Light: 610×460mm
Control Box: 285×150×110mm



RX-824

Light: 610×610mm
Control Box: 285×165×110mm

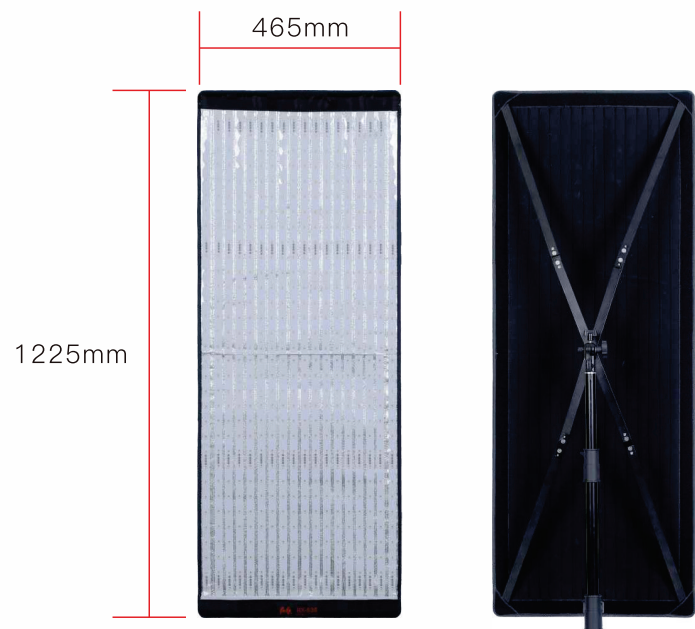

RX-836

Light: 1225×465mm
Control Box: 285×175×110mm

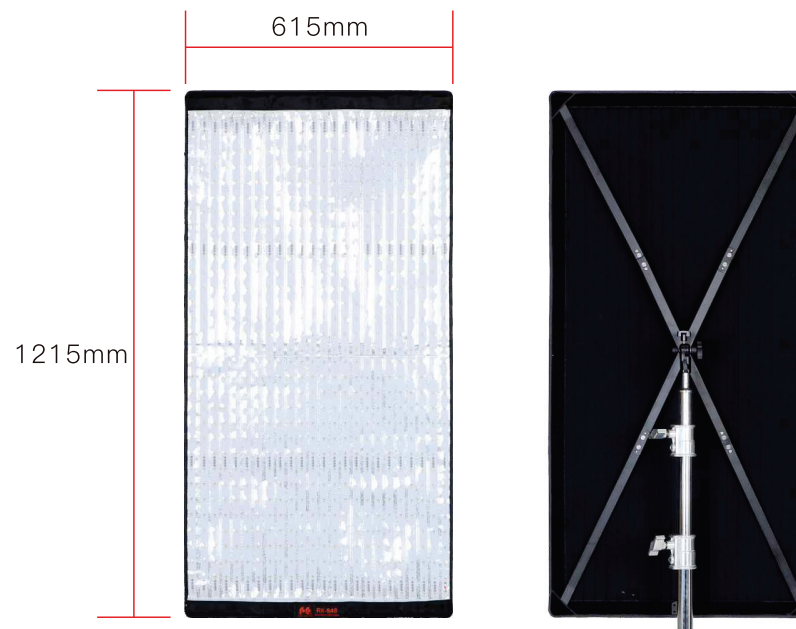

RX-848

Light: 1215×615mm
Control Box: 285×175×110mm

3/Function Introduction

In the Desal 8 series, there are 5 major settings which are CCT Mode (Bi-color mode), HSI mode, RGB mode, Color filter mode and Preset Theme mode from main menu. Select to each mode by moving the highlighted block up and down with "UP" & "DOWN" from right hand side, then press "Enter" to enter the major setting. Press "Return" to move back to previous menu.

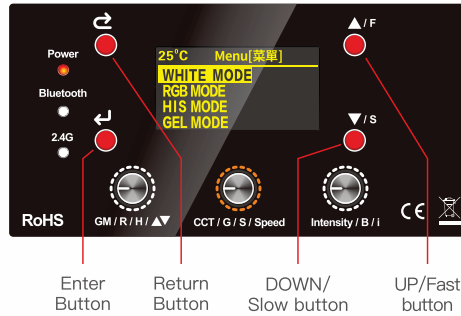

1. CCT Mode

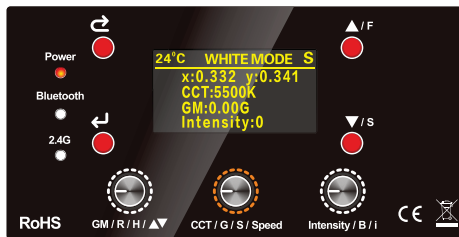

User can adjust color temperature from 2800K-10000K depends on the environment requirement. with color rendering index CIE1931xy color space calculation standard. It can light color on White LED's black body temperate through the quantification calculation, and control the color output in consistency. There are also Green and Magenta adjustment available.

2. RGB Mode

In RGB mode user can adjust RED, GREEN and BLUE color on saturation. A CIE 1931 color space X, Y coordinate will be shown according to current color setting. Adjust RED with the "R" Knob (Left knob) from 0-255 Saturation. Adjust GREEN with the "G" Knob (Middle knob) from 0-255 Saturation. Adjust BLUE with the "B" Knob (Right knob) from 0-255 Saturation.

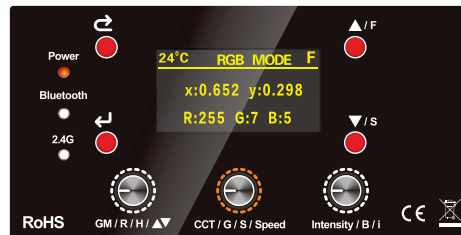

3. HSI Mode



In HSI mode user can adjust Hue, Saturation and Intensity. A CIE 1931 color space X, Y coordinate will be shown according to current color setting. Adjust Hue with the "H" Knob (Left knob) from 0-360° Hue setting. Adjust Saturation with the "S" knob (Middle knob) from 0-100%. Adjust Intensity with the "I" knob (right knob) from 0-100%

4. Filter Mode

The Desal 8 series has preset with 20 Rosco filters and 20 Lee filters.

User can enter Rosco or Lee catalogue from the Color Gel Mode menu.

Each filter can calibrate brightness from 0-100% with the knob Intensity (right knob).

User can return to the Rosco or Lee catalogue with the return button.

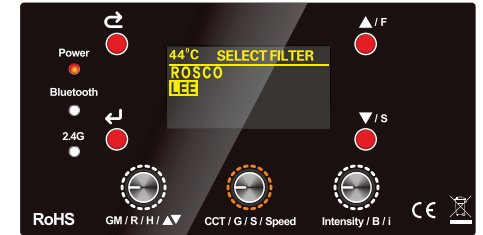

5. Theme Mode

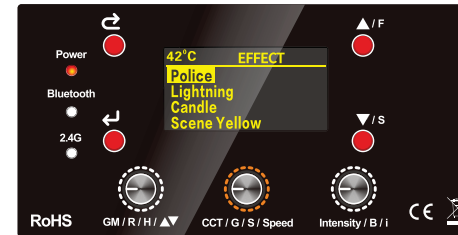

The Desal 8 series has preset with 8 theme modes which is Police car, Lighting, Candle light, Scene Yellow, Scene Blue, Scene Green, DEMO HSI and DEMO White.

Each theme is able to adjust speed with Speed knob from 0-100 (middle knob) and Intensity with intensity knob from 0-100.

6. Settings

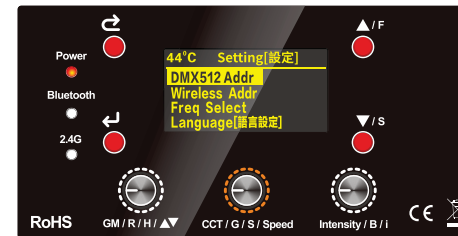

In setting mode user can adjust the fixture to match with different control methods.

1. DMX 512 Channe. User can set fixture DMX channel in this setting.
2. Wireless Address setting. User can set fixture wireless address from ch. 0-16 for smart phone application control.
3. Frequency setting. Frequency setting is for

future update purpose. Please keep the factory setting in this setting.

4. Language setting. User can adjust Chinese or English language in this setting.
5. Device Information. User can check the firmware version.



Frequency Setting



Language Setting



Device Information

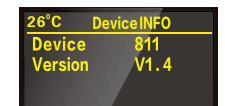

4/DMX-512 Setting

1. Set the DMX address on fixture (E.g. CH 1)



2. The DMX controllable function will take up 8 channels.



3. First 3 channels are Intensity / Color temperature / Green & Magenta.

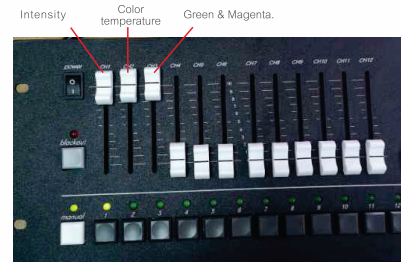
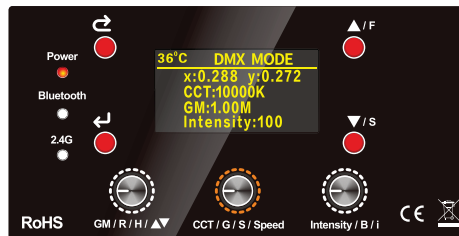

4. Channel 4 is a blocker between bi-color and RGBW, turn on Channel 4 to enable control of RGBW LEDs and make sure Channel 1 Intensity has to remain open.

5. Channel 5-8 are controlling saturation of R/G/B/W.

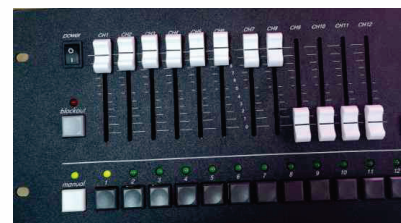
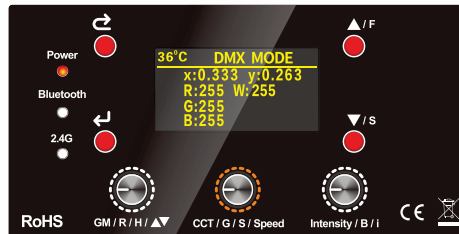

6. Further fixture will have to set the address out of the engaged 8 channels or function will be jammed.

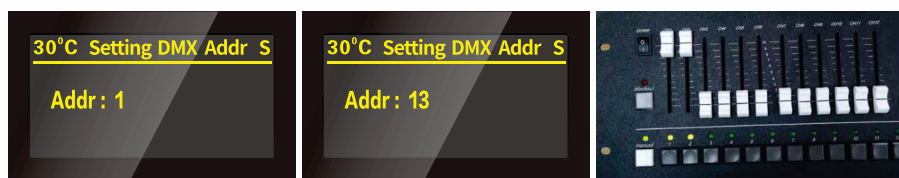

5/Application Settings

Note:

1. Wireless address detection (need to download and install the mobile app on your mobile phone and connect via Bluetooth 5.0).
2. APP operation supports Apple IOS system and Android 5.0 or above.



1. Please download the DeSal SIK app and install to the smart phone to enable smartphone application control.

2. Enter the Wireless Address Setting from Setting and set up the wireless address.

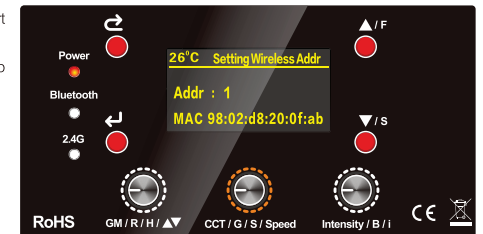

3. Open Bluetooth on smartphone and open the DeSal SIK application.

4. Tab the Bluetooth icon on the right top corner of the application to enter BLE controller page and tab "Connect"

5. A list will be loaded for all fixture searchable, pick the master fixture with the desired address to connect.

6. Back to BLE controller page and you'll see you are successfully connected. The indication light on "Bluetooth" on the fixture will have a green light on.

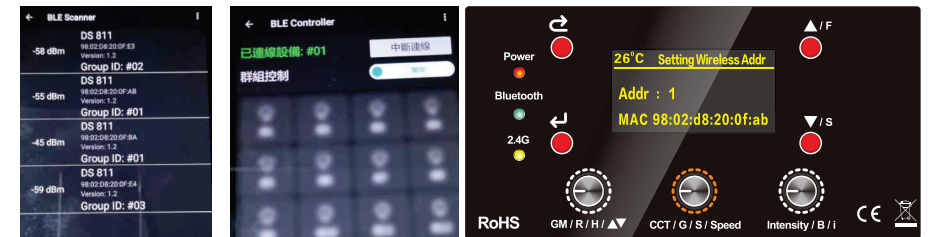

7. To control Multiple units, please tab the switch next to Group Control to enable.

8. Select the ID/Addr from all fixtures that you need to control from below icons.

9. The Yellow indicator light will be on when group control is enable. 10. To disconnect group control just simple unselect the ID that is not needed.



6/Mobile version update

1.Keep pushing "UP" "DOWN" and turn on the power. When below picture is shown, you may connect the fixture with Bluetooth.

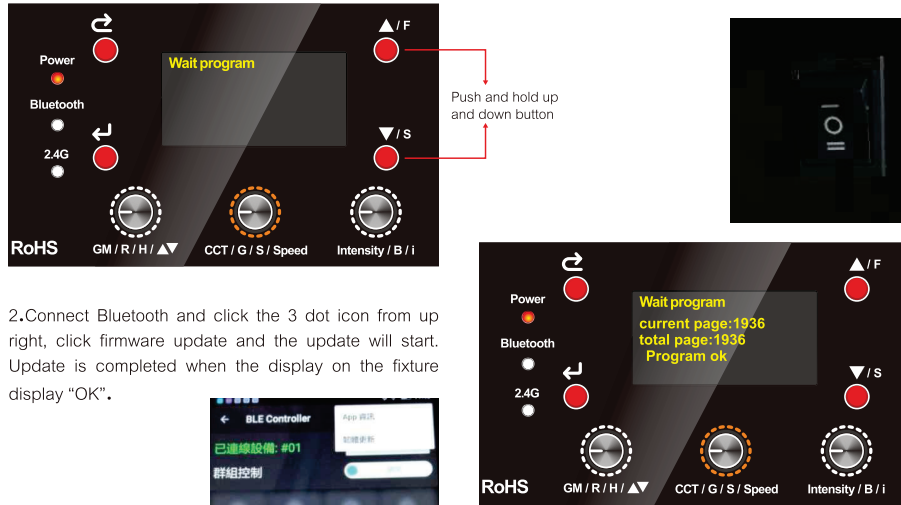

2.Connect Bluetooth and click the 3 dot icon from up right, click firmware update and the update will start. Update is completed when the display on the fixture display "OK".

Firmware update via application notice:

1. Please check if the Bluetooth connection is functional between the application and fixture.
2. During the update, old firmware will be removed from the fixture. If the signal is lost during update, the fixture may not support old firmware. User just need to reconnect and repeat the update process.
3. Fixture may not be able to function normally if it is dropping out during update but is not defective. Reconnect and repeat the update process and it'll be able to function after update is completed.

7/Accessories Introduction

This product is capatable with BP-260VL (26V) battery, barndoor, honeycomb, softbox, and grid softbox.



保修卡

产品型号 _____ 产品机号 _____

购买日期 _____

购买渠道 _____

用户名称 _____ 邮编 _____ 联系电话 _____

地址 _____

Warranty Card

Model No. _____ Serial No. _____

Date of purchase _____

Dealers of purchase _____

User Name _____ Post Code _____ Phone no. _____

Address _____